



## C46 Audio Control Center



C46

The lightning flash with arrowhead, within an equilateral triangle, is intended to alert the user to the presence of uninsulated "dangerous voltage" within the product's enclosure that may be of sufficient magnitude to constitute a risk of electric shock to persons.



AVIS RISQUE DE CHOC ELECTRIQUE - NE PAS OUVRIR.

The exclamation point within an equilateral triangle is intended to alert the user to the presence of important operating and maintenance (servicing) instructions in the literature accompanying the appliance.

**WARNING - TO REDUCE RISK OF FIRE OR ELECTRICAL SHOCK, DO NOT EXPOSE THIS EQUIPMENT TO RAIN OR MOISTURE.**

**NO USER-SERVICEABLE PARTS INSIDE. REFER SERVICING TO QUALIFIED PERSONNEL.**

To prevent the risk of electric shock, do not remove cover or back. No user serviceable parts inside.

## IMPORTANT SAFETY INSTRUCTIONS!

**PLEASE READ THEM BEFORE OPERATING THIS EQUIPMENT.**

### General:

1. Read these instructions.
2. Keep these instructions.
3. Heed all warnings.
4. Follow all instructions.
5. **Warning: To reduce risk of fire or electrical shock, do not expose this equipment to rain or moisture. This unit is capable of producing high sound pressure levels. Continued exposure to high sound pressure levels can cause permanent hearing impairment or loss. User caution is advised and ear protection is recommended when playing at high volumes.**
6. **Caution: to prevent electrical shock do not use this (polarized) plug with an extension cord, receptacle or other outlet unless the blades can be fully inserted to prevent blade exposure.**  
**Attention: pour pevenir les chocs elecriques pas utiliser cette fiche polarisee avec un prolongateur, une prise de courant ou un autre sortie de courant, sauf si les lames peuvent etre inserees afond ans en laisser aucune partie a decouvert.**
7. Unplug this equipment during lightning storms or when unused for long periods of time.
8. Only use attachments/accessories specified by the manufacturer.

### Installation:

9. The equipment shall be installed near the AC Socket Outlet and the disconnect device shall be easily accessible.
10. Do not block any ventilation openings. Install in accordance with the manufacturer's instructions.
11. Do not install near any heat sources such as radiators, heat registers, stoves, or other equipment (including amplifiers) that produce heat.
12. Do not use this equipment near water.
13. Do not expose this equipment to dripping or splashing and ensure that no objects filled with liquids, such as vases, are placed on the equipment.
14. Use only with the cart, stand, tripod, bracket, or table specified by the manufacturer, or sold with the equipment. When a cart is used, use caution when moving the cart/equipment combination to avoid injury from tip-over.



### Connection:

15. Connect this equipment only to the type of AC power source as marked on the unit.
16. Protect the power cord from being walked on or pinched particularly at plugs, convenience receptacles, and the point where they exit from the equipment.
17. Do not defeat the safety purpose of the polarized or grounding-type plug.

---

A polarized plug has two blades with one wider than the other. A grounding type plug has two blades and a third grounding prong. The wide blade or the third prong are provided for your safety. If the provided plug does not fit into your outlet, consult an electrician for replacement of the obsolete outlet.

18. Do not overload wall outlets, extension cords or integral convenience receptacles as this can result in a risk of fire or electric shock.
19. To completely disconnect this equipment from the AC Mains, disconnect the power supply cord plug from the AC receptacle.

#### **Care of Equipment:**

20. Clean only with a dry cloth.
21. Do not permit objects or liquids of any kind to be pushed, spilled and/or fall into the equipment through enclosure openings.
22. Unplug the power cord from the AC power outlet when left unused for a long period of time.

#### **Repair of Equipment:**

23. Refer all servicing to qualified service personnel. Servicing is required when the equipment has been damaged in any way, such as power-supply cord or plug is damaged, liquid has been spilled or objects have fallen into the equipment, the equipment has been exposed to rain or moisture, does not operate normally, or has been dropped.
24. Do not attempt to service beyond that described in the operating instructions. All other service should be referred to qualified service personnel.
25. When replacement parts are required, be sure the service technician has used replacement parts specified by McIntosh or have the same characteristics as the original part. Unauthorized substitutions may result in fire, electric shock, or other hazards.
26. Upon completion of any service or repairs to this product, ask the service technician to perform safety checks to determine that the product is in proper operating condition.

## **Thank You**

Your decision to own this McIntosh C46 Audio Control Center ranks you at the very top among discriminating music listeners. You now have "The Best." The McIntosh dedication to "Quality," is assurance that you will receive many years of musical enjoyment from this unit.

Please take a short time to read the information in this manual. We want you to be as familiar as possible with all the features and functions of your new McIntosh.

## **Please Take A Moment**

The serial number, purchase date and McIntosh Dealer name are important to you for possible insurance claim or future service. The spaces below have been provided for you to record that information:

**Serial Number:** \_\_\_\_\_

**Purchase Date:** \_\_\_\_\_

**Dealer Name:** \_\_\_\_\_

## **Technical Assistance**

If at any time you have questions about your McIntosh product, contact your McIntosh Dealer who is familiar with your McIntosh equipment and any other brands that may be part of your system. If you or your Dealer wish additional help concerning a suspected problem, you can receive technical assistance for all McIntosh products at:

McIntosh Laboratory, Inc.  
2 Chambers Street  
Binghamton, New York 13903  
Phone: 607-723-1545  
Fax: 607-723-3636

## **Customer Service**

If it is determined that your McIntosh product is in need of repair, you can return it to your Dealer. You can also return it to the McIntosh Laboratory Service Department. For assistance on factory repair return procedure, contact the McIntosh Service Department at:

McIntosh Laboratory, Inc.  
2 Chambers Street  
Binghamton, New York 13903  
Phone: 607-723-3515  
Fax: 607-723-1917

## Table of Contents

Safety Instructions .....	2
Thank You and Please Take a Moment .....	3
Technical Assistance and Customer Service .....	3
Table of Contents and Important Information .....	4
Connector Information .....	4
Introduction .....	5
Performance Features .....	5
Dimensions .....	6
Installation .....	7
<b>Connections</b>	
Rear Panel Connections .....	8
How to Connect for Power Control .....	9
How to Connect for Audio and Data Control .....	10
How to Connect for a Second Room .....	11
<b>Front Panel Features</b>	
Front Panel Controls, Displays, Push-buttons, and Switches .....	12
<b>Setup</b>	
How to Operate the Setup Mode .....	13
Default Settings .....	13
Display Brightness .....	13
Re-Title Inputs .....	14
Input Trim Level .....	14
Auto Tone .....	15
Remote Control Selection .....	15
Firmware Version .....	15
<b>Operation</b>	
Remote Control Push-buttons .....	16
How to Operate by Remote Control .....	17
How to Operate the C46 .....	18
Notes .....	21
<b>Additional Information</b>	
Specifications and Performance Chart .....	22
Packing Instruction .....	23

## Important Information

1. Connecting Cable is available from the McIntosh Parts Department:  
**Data and Power Control Cable Part No. 170-202**  
Six foot, shielded 2 conductor, with 1/8 inch stereo mini phone plug on each end.
2. For additional information on Audio Connections, refer to the Owner's Manual(s) for the component(s).
3. The Main AC Power going to the C46 and any other McIntosh Component(s) should not be applied until all the system components are connected together. When the C46 and other McIntosh Components are in their Standby Power Off Mode, the Microprocessor's Circuitry inside each component is active and communication is occurring between them. Failure to do so could result in

malfunctioning of some or all of the system's normal operations.

4. Up to four Sensors can be wired in parallel for Remote Control of the C46 from other rooms.
5. Balanced and Unbalanced Inputs and Outputs can be mixed. For example, you may connect signal sources to Unbalanced Inputs and send signals from the Balanced Outputs. You can also use Balanced and Unbalanced Outputs simultaneously, connected to different Power Amplifiers.
6. A McIntosh Power Controller may be added to the C46 to provide AC Power Switching to components that do not have Power Control Connections. See your McIntosh Dealer for additional information.
7. Sound Intensity is measured in units called Decibels and "dB" is the abbreviation.
8. The Number 1 Input of the C46 allows for connection of either a High Level Source (such as a second Tuner) or a Low Level Source (such as a turntable with a moving magnet cartridge). The slide switch located between the AUX and PHono Jacks on the Rear Panel determines which Inputs Jacks become active. The Default Title for the Number 1 Input that appears on the Front Panel Alphanumeric Display is AUX. If the Number 1 Input switch is set to the PHono, the Title may be changed by going into the Setup Mode and renaming the Input. Refer to page 14.

## Connector Information

### XLR Connectors

Below is the Pin configuration for the XLR Balanced Input and Output Connectors on the C46. Refer to the diagram for connection:

- PIN 1: Shield/Ground
- PIN 2: + Input
- PIN 3: - Input

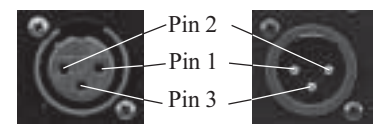

### Power Control and Trigger Connectors

The C46's Power Control Outputs provide a 5 volt signal. Use a 1/8 inch stereo mini phone plug to connect to the Power Control Input on other McIntosh Components.

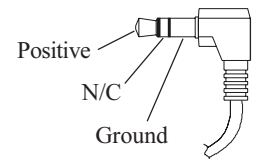

### Data Port Connector

The C46's Data Port Output provides Remote Control Signals. Use a 1/8 inch stereo mini phone plug to connect to the Data Port Inputs on McIntosh Source Units.

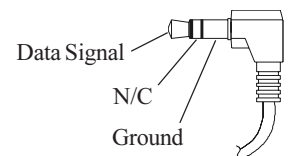

### Introduction

---

The new McIntosh C46 Audio Control Center offers a highly refined combination of useful operating features with totally transparent electronic performance. For example you can take advantage of the eight-band equalizer to achieve the finest possible reproduction of digital source music as well as valuable music from earlier recording technology. Combine a C46 with a McIntosh Power Amplifier and you will enjoy a system of unparalleled performance.

### Performance Features

---

- **Balanced Inputs and Outputs**

One balanced high level Input and three balanced Outputs are provided.

- **Precision Tracking Volume Control**

Volume levels are controlled by a new Multi-Stage Precision Digitally Controlled Attenuator System with a tracking accuracy of 0.1dB. Levels change in 214 individual 0.5dB steps.

- **Variable Rate Volume and Balance Control Selection**

The C46 Control Center's Volume and Balance Control Circuitry provides an ideal rate of change with control rotation.

- **Eight Tone Controls with Assignable Bypass**

The Tone Controls provide 12dB of boost or cut at center frequencies of 20, 35, 70, 150, 300, 600, 1200 and 4000Hz. When a Tone Control is in the center or flat position, all Tone Circuit Components are removed from the Signal Path of any selected input.

- **Alphanumeric Fluorescent Display**

The Multifunction Front Panel Display indicates the Source Selection, Volume and Balance Levels. Setup Mode Selections and Adjustments are also displayed. The display intensity is fully adjustable.

- **Electromagnetic Input Switching**

Digital Logic integrated circuits drive Electromagnetic Switches on all Inputs and operating functions for reliable, noiseless, distortion free switching.

- **Input Level Trim Adjustment**

All eight Inputs on the C46 can be matched in level, so there are no abrupt changes in volume levels between the different Inputs.

- **Record Monitor Function**

There is a Record Monitor Function for checking the progress of a recording from any of the eight inputs.

- **Title Reassignment**

Any of the eight Inputs can have their Input Title reassigned to match the sources in the system.

- **Two Signal Processor Loops**

Separate front panel switched Signal Processor Loops are provided for the listen and record circuits.

- **Precision Parts**

Only the finest precision 1% tolerance resistors are used throughout.

- **Low Distortion**

Distortion levels of all types are less than 0.002%. Music is amplified with total transparency and accuracy.

- **Moving Magnet Phono Input**

There is a Precision Phono Preamplifier for Moving Magnet Cartridges.

- **Remote Control**

The C46 includes a Remote Control that allows remote operation of the Front Panel Controls and Push-buttons.

- **Optional External Sensor Input**

There are provisions for connecting External Sensors, which allow for enjoyment of your McIntosh System from other room(s) in your home via the Remote Control.

- **Output Switching**

Front panel Output Push-buttons control two Switched Outputs that allow sending signals to two separate Power Amplifiers.

- **Fiber Optic Solid State Front Panel Illumination**

The Illumination of the Front Panel Nomenclature is accomplished by the combination of custom designed Fiber Optic Light Diffusers and Light Emitting Diodes (LEDs). This provides even Front Panel Illumination, together with the extremely long life LEDs.

### Dimensions

The following dimensions can assist in determining the best location for your C46. There is additional information on the next page pertaining to installing the C46 into cabinets.

Front View of the C46



Rear View of the C46

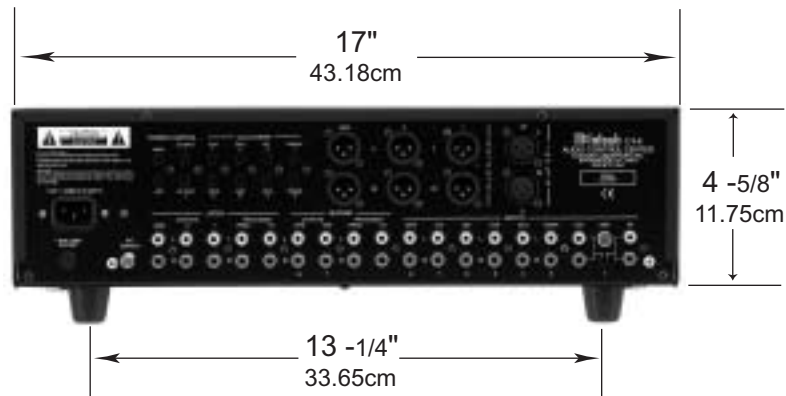

Side View of the C46

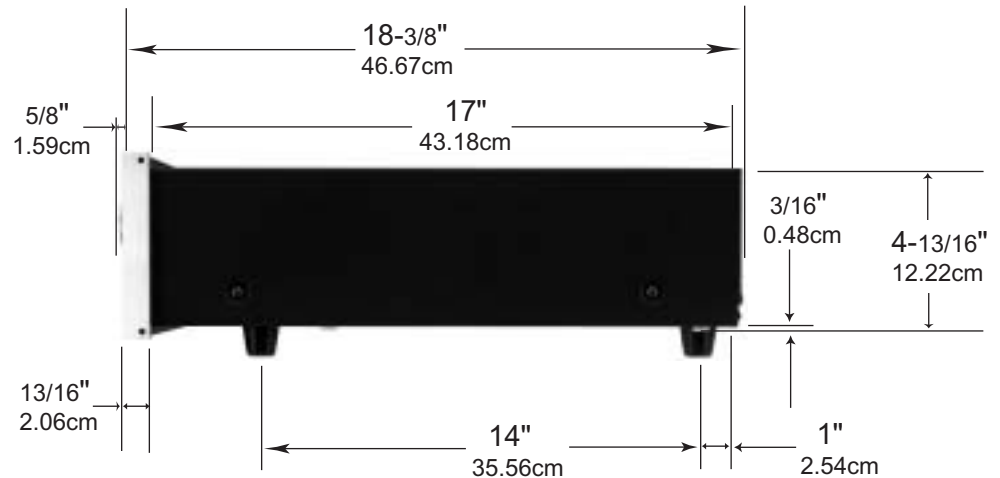

**Installation**

The C46 can be placed upright on a table or shelf, standing on its four feet. It also can be custom installed in a piece of furniture or cabinet of your choice. The four feet may be removed from the bottom of the C46 when it is custom installed as outlined below. The four feet together with the mounting screws should be retained for possible future use if the C46 is removed from the custom installation and used free standing. The required panel cutout, ventilation cutout and unit dimensions are shown.

Always provide adequate ventilation for your C46. Cool operation ensures the longest possible operating life for any electronic instrument. Do not install the C46 directly above a heat generating component such as a high powered amplifier. If all the components are installed in a single cabinet, a quiet running ventilation fan can be a definite asset in maintaining all the system components at the coolest possible operating temperature.

A custom cabinet installation should provide the following minimum spacing dimensions for cool operation. Allow at least 2 inches (5.08cm) above the top, 2 inches (5.08cm) below

the bottom and 1 inch (2.54cm) on each side of the Audio Control Center, so that airflow is not obstructed. Allow 19-1/2 inches (49.53cm) depth behind the front panel. Allow 1-1/8 inch (2.9cm) in front of the mounting panel for knob clearance. Be sure to cut out a ventilation hole in the mounting shelf according to the dimensions in the drawing.

**C46 Front Panel Custom Cabinet Cutout**

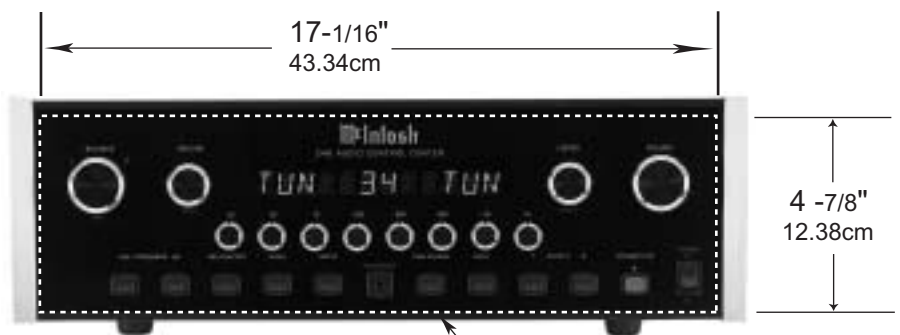

**C46 Side View in Custom Cabinet**

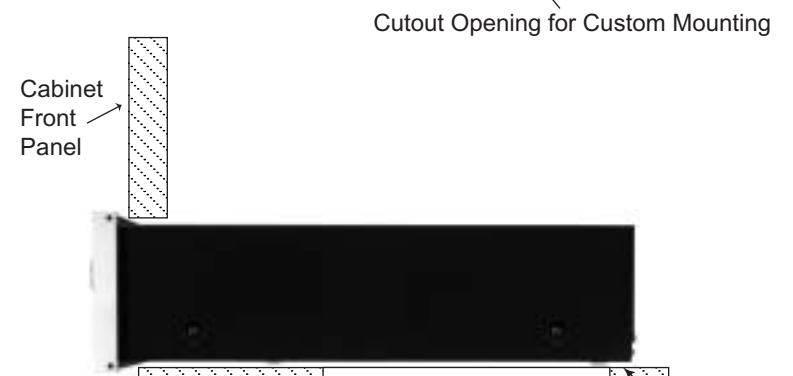

**C46 Bottom View in Custom Cabinet**

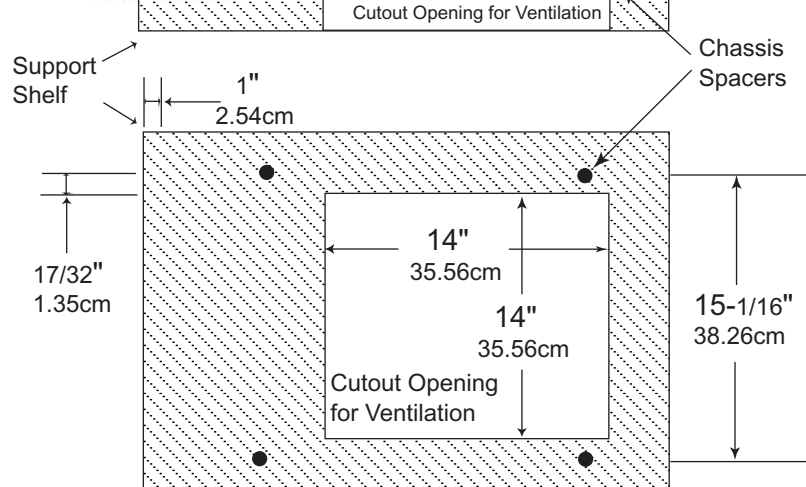

Connect the power cord to a live AC outlet. Refer to information on the back panel of the C46 to determine the correct voltage

**POWER CONTROL MAIN** Output sends a turn-on trigger to a McIntosh Power Amplifier when the C46 is switched On

**DATA PORTS** send control signals to compatible source components allowing remote operation thru the C46 System

**1 and 2 Balanced OUTPUTS** contain Listen signals and turn On/Off with the front panel **OUTPUTS** Push-buttons

**POWER CONTROL ACC** Output sends a turn-on trigger to a McIntosh Source Unit when the C46 is switched On

**POWER CONTROL 1 and 2** Outputs send turn-on triggers to a McIntosh Power Amplifier when the C46 Front Panel Output 1 and/or 2 is On

**MAIN Balanced OUTPUTS** contain Listen program signals at all times

**CD balanced INPUTS** accept high level program source signals

Ground connection for turntables



The **EXTERNAL SENSOR** Jack permits the connection of a McIntosh IR Sensor for remote operation

**LISTEN PROCESSOR FROM** and **TO** allows an external signal processor to be connected for use in the Listen Mode

**RECORD PROCESSOR FROM** and **TO** allows an external signal processor to be connected for use in the Record Mode

**AUX** accepts high level program source signals, **PH** accepts signals from a Moving Magnet phono cartridge, and the small slide switch selects which one of these two inputs is active when either Front Panel **LISTEN** or **RECORD** Switch is set to **PHONO** or **AUX**

**Main Fuse holder**, refer to information on the back panel of the C46 to determine the correct fuse size and rating

**LISTEN OUTPUTS MAIN** contain Listen Program Signals at all times, **OUTPUTS 1 and 2** contain Program Signals and switch On/Off with the Front Panel **OUTPUTS** Push-buttons

**TAPE and VCR OUTPUTS** contain record out signals

**TAPE, VCR, SAT, DVD, CD2 and TUNER INPUTS** accept high level program source signals



## How to Connect for Power Control

1. Connect a Control Cable from the C46 POWER CONTROL Accessory Jack to the Power Control In on the McIntosh CD Player.
2. Connect a Control Cable from the McIntosh CD Player Power Control Out Jack to the Power Control In Jack on the McIntosh Tuner.
3. Connect a Control Cable from the McIntosh Tuner Power Control Out Jack to the Power Control Jack on the optional McIntosh Power Control unit.
4. Connect a Control Cable from the C46 MAIN POWER CONTROL Jack to the Power Control In Jack on the McIntosh Power Amplifier.

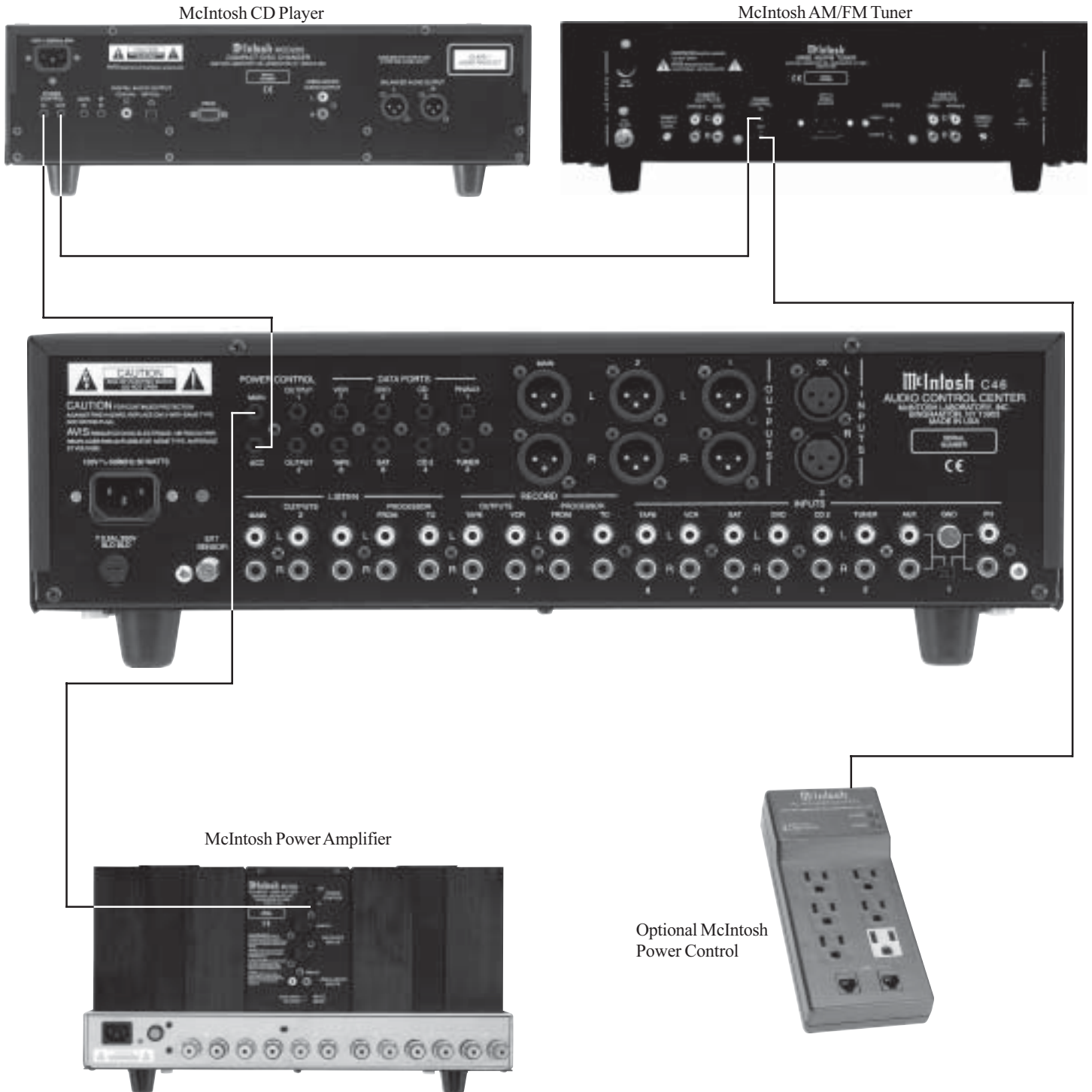

### How to Connect for Audio and Data Control

1. Connect Audio Cables from the McIntosh C46 MAIN Balanced OUTPUTS to the McIntosh Power Amplifier Balanced INPUTS.

*Note: The unbalanced MAIN Audio Outputs and unbalanced Power Amplifier Inputs may be used instead of the Balanced Connections.*

2. Connect Audio Cables from the McIntosh CD Player Balanced Audio Outputs to the C46 CD Balanced INPUTS.

*Note: The unbalanced Audio Outputs and Inputs may be used instead of the Balanced Connections.*

3. Connect an Audio Cable from a McIntosh Tuner 1 Outputs to the C46 TUNER INPUTS.

4. Connect an Audio Cable from a Turntable to the PH INPUTS, the Turntable Ground Connection to the GND Grounding Post and slide the AUX/PH Switch towards the PH Input jacks.

5. Connect an Audio Cable from the C46 TAPE OUT-

PUTS to the Record Inputs of a Tape Recorder and from the C46 TAPE INPUTS to a Tape Recorder Outputs.

6. Connect an Audio Cable from the C46 LISTEN PROCESSOR TO to the Inputs of a Signal Processor and from the C46 LISTEN PROCESSOR FROM to the Signal Processor Outputs.

7. Connect a Control Cable from the C46 CD DATA PORT Jack to the DATA IN Jack on the McIntosh CD Player.

8. Connect a Control Cable from the C46 TUNER DATA PORT Jack to the DATA IN Jack on the McIntosh Tuner.

*Note: By adding a McIntosh Remote Control Translator to the C46, non McIntosh Source Devices such as a Satellite Receiver can be remotely controlled using a McIntosh Remote Control and Keypad/Sensor.*

9. Connect the C46 Power Cord to a live AC outlet.

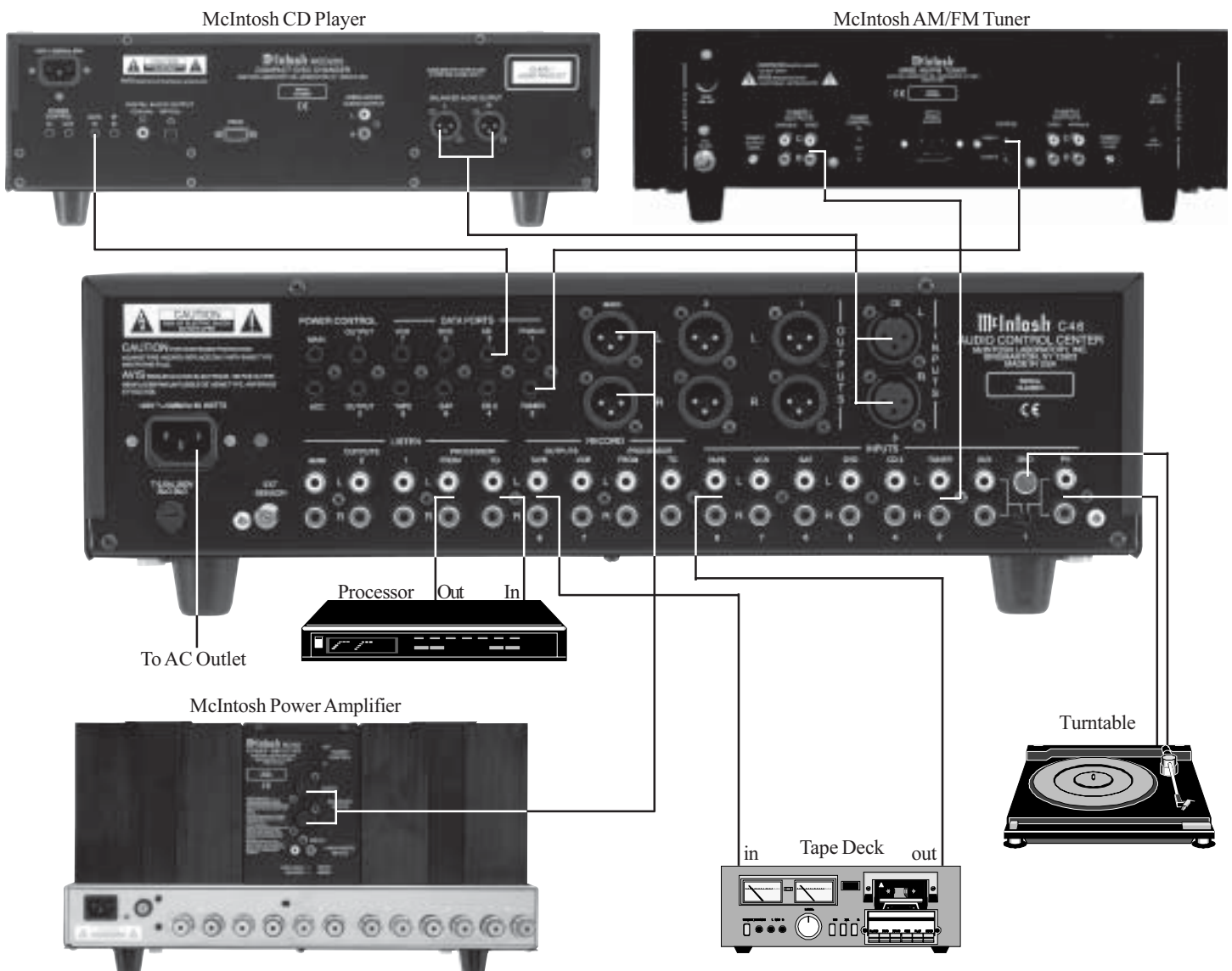

**How to Connect for a Second Room**

1. Connect Audio Cables from the C46 Balanced OUTPUTS 2 to the Second Power Amplifier Balanced Inputs.

*Notes: The unbalanced Audio OUTPUTS 2 and unbalanced Power Amplifier Inputs may be used instead of the Balanced Connections. When a second room is connected, it is sometimes desirable to switch Off the Loudspeakers in the Main Listening Room. This can be accomplished by connecting the Main Power Amplifier to the C46 OUTPUTS 1 instead of the MAIN OUTPUTS, so they can be switched Off by the Front Panel OUTPUTS 1 Push-button.*

2. Connect a Control Cable from the C46 POWER CONTROL 2 Jack to the Power Control In of a McIntosh

Power Amplifier.

3. Connect a RG6 or RG59U coaxial cable from the EXTERNAL SENSOR Jack to a Keypad.

*Note: A Wall Mounted IR Sensor may also be used in place of the Keypad.*

Keypad

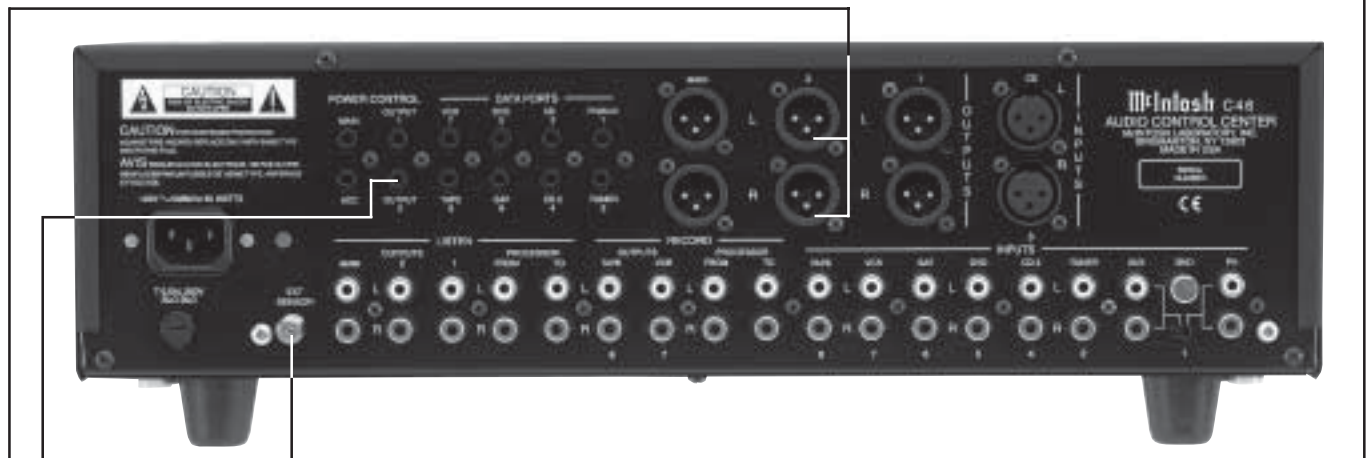

McIntosh Power Amplifier

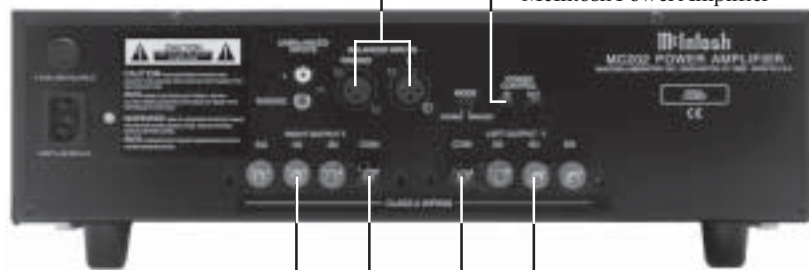

Right Loudspeaker  
4 ohms

Left Loudspeaker  
4 ohms

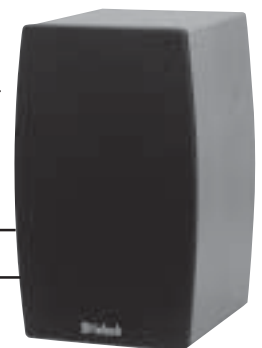

**BALANCE** control allows the adjustment of the relative volume levels for each channel and is used for setup functions

**DISPLAY** indicates the Sources, Volume/Balance Levels, Operational Functions and Setup Mode Settings

**LISTEN** control selects the program signals that are listened to and unbalanced outputs

**VOLUME** control adjusts the listening volume level and is used for setup functions

**RECORD** control selects the program signals that are available to record from and is used for setup functions

**Tone Controls** provide 10dB of boost or cut at the center frequencies indicated above each control

**IR Sensor** receives commands from a Remote Control



**REC PROCESSOR** Push-button turns the Record Processor loop On or Off

**HEADPHONES** jack accepts dynamic headphones

**MUTE** Push-button mutes audio in all Listen outputs

**POWER** Switch switches all AC Power completely On or Off

**LIS PROCESSOR** Push-button turns the Listen Processor loop On or Off

**MONO** Push-button combines left and right stereo signals to mono at all Main, Amplifier and Listen Outputs

**OUTPUTS 1 and 2** Push-buttons allow the C46 to switch Power Control and Audio to two separate stereo Power Amplifiers

**REC MONITOR** Push-button switches the RECORD Output signals to the Listen circuit so the Program Signals sent to the Record Outputs are audible

**SETUP** Mode Push-button allows the changing of the default settings for Inputs, Levels, Special Functions and the Display

**TONE BYPASS** Push-button allows the audio signal to totally bypass the Equalizer Control Circuitry

**STANDBY/ON** Push-button turns the C46 ON or OFF (Standby)

## How to Operate the Setup Mode

This McIntosh C46 has been factory configured for immediate use without the need for adjustments. Changes can be made to the default settings. A Setup Feature is provided to customize the operating settings using the Front Panel Alphanumeric Display. Refer to page 12.

1. Press the POWER Switch to ON, the Red LED above the STANDBY/ON Push-button lights to indicate the C46 is in Standby mode. To switch On the C46, press the STANDBY/ON Push-button.
2. Press the C46 Front Panel SETUP Push-button. The LED above the SETUP Push-button will illuminate and the Front Panel Alphanumeric Display will indicate DISPLAY 10. Refer to figure 1.

*Note: The Front Panel Display will indicate DISPLAY 10 the first time. After the first time, it will display whatever Setup Mode Menu Item was last accessed.*

3. Rotate the Front Panel BALANCE (Menu) Control and notice that the Setup Mode advances through different adjustment selections and one informational display.

*Note: The C46 Front Panel Controls used during setup may require clockwise or counterclockwise rotation to access all options.*

4. To exit from a specific Setup Mode, press the SETUP Push-button. The LED above the SETUP Push-button will extinguish and the Front Panel Display will revert back to its normal display. Refer to figure 2.



Figure 2

## Default Settings

The following listings indicate the default settings and the page number for instructions on how to change a setting.

Setup Function Name	Setting	Page Number
Alphanumeric Display Brightness	10	13
Text Length	Full	13
Trim (Input Level)	00	14
Input:		14
Number	Title	
1 .....	AUX	
2 .....	TUNER	
3 .....	CD	
4 .....	CD2	
5 .....	DVD	
6 .....	SAT	
7 .....	VCR	
8 .....	TAPE	
Volume Display	Percentage	15
Auto Tone	Off	15
Remote (Control Type)	Normal	15
Version (C46 Firmware)	— . — —	15

## Display Brightness

The Front Panel Alphanumeric DISPLAY Brightness may be varied from 1 (Dim) to 15 (Bright). Follow the steps below for changing the brightness. Refer to figure 1.



Figure 1

1. Press the SETUP Push-button to access the Setup Mode.
2. Rotate the Front Panel BALANCE (Menu) Control until the word DISPLAY 10 appears.
3. Rotate the LISTEN Control until the desired Display Brightness is achieved.
4. Press the SETUP Push-button to exit the Setup Mode.

## Text Display Options

There are two choices for displaying the Input Names on Front Panel Alphanumeric Display, TEXT FULL or TEXT SHORT. The TEXT FULL Mode displays the Volume Setting together with the name of the Listen Input Selected. Refer to figure 3. The TEXT SHORT Mode displays the name of Record Input Selected, the Volume Setting and the name of the Listen Input Selected. Refer to figure 4.



Figure 3



Figure 4

1. Press the SETUP Push-button to access the Setup Mode.
2. Rotate the BALANCE Control Knob until the words TEXT FULL appears. Refer to figure 5.



Figure 5

3. Rotate the LISTEN Switch Knob until the display indicates TEXT SHORT. Refer to figure 6.



Figure 6

4. Press the SETUP Push-button to exit the Setup Mode.

## Input Trim Level

Various Source Components can have slightly different volume levels. This could result in the readjustment of the C46 Volume Control when changing Inputs. The C46 allows the adjustment of input volume levels for each source. The Tuner and CD Inputs are used in the following example.

*Notes: The Trim range of adjustment in volume level is  $\pm 6$ dB and is retained in permanent memory until a change is made. The Tuner Input Volume Level can serve as a reference or choose another Input. The reference Input Source should be set to a Trim Level of 0.0. The Tape/VCR Output Levels are unaffected by any changes in the Trim Settings.*

1. Rotate the LISTEN Control to select the Tuner Input and adjust the VOLUME Control to the desired listening level.
2. Press the SETUP Push-button to access the Setup Mode.
3. Rotate the BALANCE (Menu) Control until the words TRIM 0.0 TUN appears. Refer to figure 7.

*Note: If the Tuner Trim Level is not 0.0 then rotate the VOLUME Control until it is.*



Figure 7

4. Rotate the LISTEN Control until the words TRIM 0.0 CD appears. Refer to figure 8.



Figure 8

5. Rotate the VOLUME Control or the Remote Control Trim Level Push-buttons, until the Volume Level of the CD Input is the same as the Tuner Volume Level. Refer to figure 11. Figure 9 indicates a 2.5dB decrease in the CD Level.

6. Repeat steps 3, 4 and 5 until all the Inputs with sources



Figure 9

connected to the C46 have the same relative volume levels when switching between inputs.

7. Press the SETUP Push-button to exit the Setup Mode.

*Note: A chart has been provided, on page 21 to record changes made from the default settings.*

## Re-Title Inputs

The C46 has Audio Inputs numbered 1 thru 8. These inputs already have assigned titles that will allow for immediate hookup, operation and enjoyment.

If these starting assignments do not match up with components in your system, they may be reassigned from the default settings. The following example will illustrate how to rename the AUX Input to PHONO. After completing the steps below and input number 1 (AUX) is selected, the Front Panel Alphanumeric Display will now indicate PHONO.

*Notes: 1. Unused Inputs may be switched Off so they will not be available from the Front Panel, the Remote Control or the Keypad. This is accomplished by rotating the LISTEN Control counterclockwise, instead of clockwise, to chose another Input Title in the steps below. Refer to figure 10.*



Figure 10

2. Additional Input Titles include TP2 (TAPE 2), LV, TV, VCR2; and are available for all the Inputs except the AUX Input. The AUX Input Titles include TAPE 2, LV, TV and PH (PHONO). When an Input with a default Title is changed, the Title will become available for reassignment to another Input by rotating the LISTEN Control counterclockwise. This allows for the reorienting of adjacent Titles as the LISTEN or RECORD Control are rotated.

1. Press the SETUP Push-button to access the Setup Mode.
2. Rotate the BALANCE (Menu) Control until the words INPUT 2 \* TUN appears. Refer to figure 11.

*Note: The \* Symbol indicates the default Input Title.*



Figure 11

3. Rotate the RECORD Control until the words INPUT 1 \* AUX appears. Refer to figure 12.



Figure 12

4. Rotate the LISTEN Control clockwise until the Front Panel Alphanumeric Display indicates INPUT 1 PH appears. Refer to figure 13.



Figure 13

5. Press the SETUP Push-button to exit the Setup Mode.

## Volume Display

The Volume Display Feature allows the Front Panel Alphanumeric Display to indicate the volume level either in Decibels (dB) or as a Percentage of the total volume.

1. Press the SETUP Push-button to access the Setup Mode.
2. Rotate the BALANCE (Menu) Control until the words DISP PERCENT appears. Refer to figure 14.



Figure 14

3. Rotate the LISTEN Control until the Front Panel Alphanumeric Display indicates DISP DECIBEL. Refer to figure 15.



Figure 15

4. Press the SETUP Push-button to exit the Setup Mode.

## Auto Tone

The Auto Tone Feature activates the TONE BYPASS Dynamic Memory Circuit. When the Auto Tone Feature is set to the On position, the C46 will automatically remember, for each Input, whenever the Tone Bypass Circuit is On or Off.

1. Press the SETUP Push-button to access the Setup Mode.
2. Rotate the BALANCE (Menu) Control until the words AUTOTONE OFF appears.
3. Rotate the LISTEN Control until the Front Panel Alphanumeric Display indicates AUTOTONE ON. Refer to figure 16.



Figure 16

4. Press the SETUP Push-button to exit the Setup Mode.

## Remote Control Selection

The Remote Control included with the C46 utilizes the NORMal McIntosh Control Codes. The Second Set of Control Codes the C46 will respond to is referred to as the ALTERNate Codes. The ALTERNate Codes are for when the C46 is used in the same location with another McIntosh Control Center/Multichannel Processor/Decoder. This will prevent the Remote Control from affecting the operation of both units at the same time.

*Note: If the ALT Remote Control Code is selected, the C46 will not respond using the supplied McIntosh Remote Control.*

1. Press the SETUP Push-button to access the Setup Mode.
2. Rotate the Front Panel BALANCE (Menu) Control until the words REMOTE NORM appears.
3. Rotate the Front Panel LISTEN Control until the Front Panel Alphanumeric Display indicates REMOTE ALT. Refer to figure 17.



Figure 17

4. Press the SETUP Push-button to exit the Setup Mode.

## Firmware Version

The C46 functionality is controlled by internal software that is known as Firmware. The Version of the Firmware in the C46 can be identified at any time by utilizing the Setup Mode.

1. Press the SETUP Push-button to access the Setup Mode.
2. Rotate the Front Panel BALANCE (Menu) Control until the word VERSION \_ . \_ \_ appears. Refer to figure 18.



Figure 18

3. The number after the word VERSION is the Firmware number.
4. Press the SETUP Push-button to exit the Setup Mode.

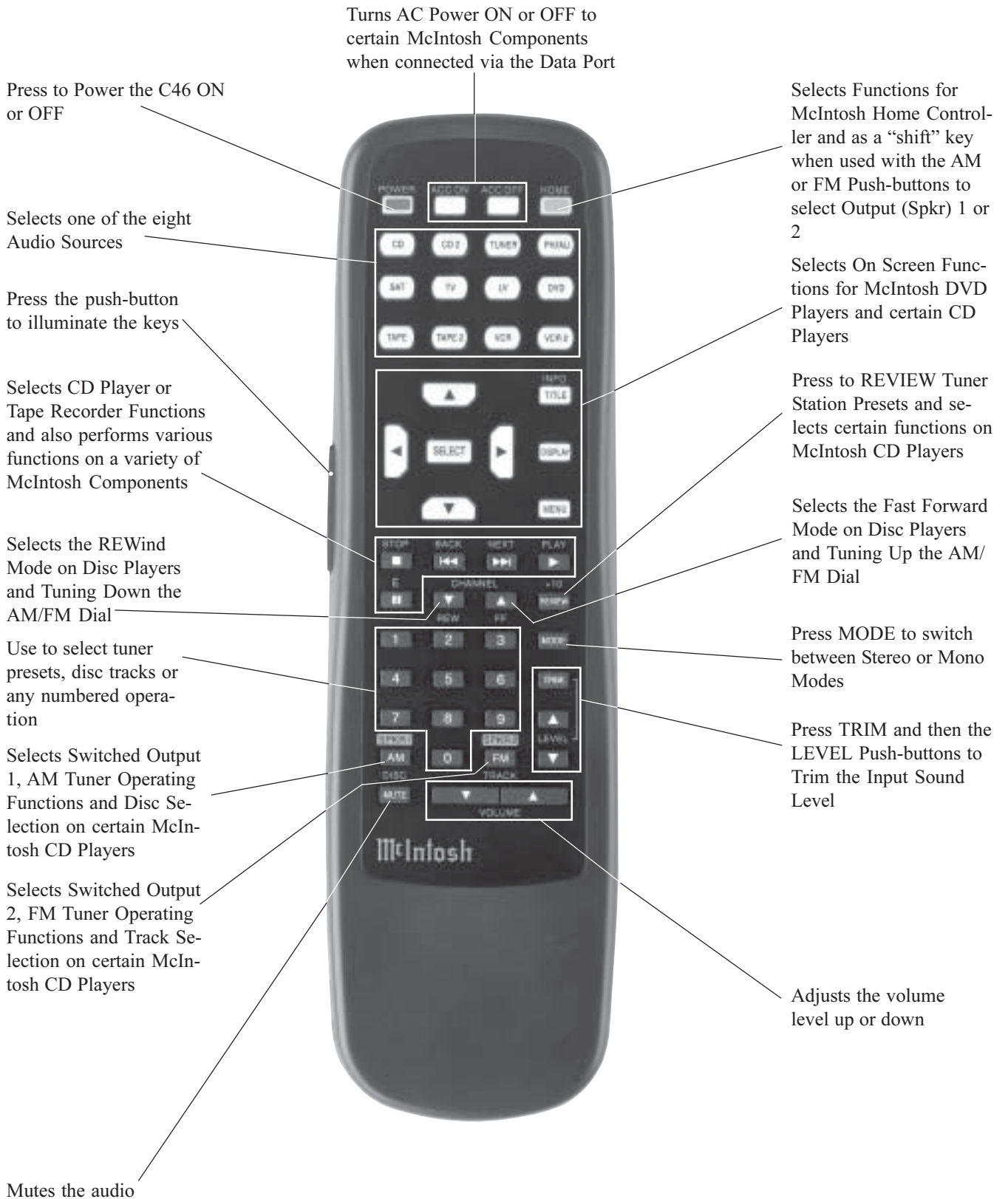



### How to Operate by Remote Control

---

The supplied Remote Control is capable of directly controlling the functions of contemporary McIntosh Source Components connected to the C46. Earlier McIntosh source components and other brand source components can be controlled by the C46 with the addition of a McIntosh Remote Control Translator (RCT).

*Note: Your McIntosh Dealer can assist you with the installation and operation of the Remote Control Translator (RCT).*

#### Mute

Press the MUTE Push-button to mute audio at the Preamplifier Outputs, except the TAPE OUTPUTS. Press MUTE a second time to unmute audio.

#### Mono

Press the MODE Push-button to combine Left and Right Stereo Signals to Mono at all the Preamplifier Outputs, except the Tape Outputs.

#### Trim and Level

Press the TRIM Push-button to activate the Input TRIM Function. Press the LEVEL Up▲ and Down▼ Push-buttons to Trim the Input Sound Level. For additional information refer to page 13.

#### Input Source Selection

Press any of the eight Input Push-buttons to select a program source.

#### CD/Tape Functions

Use these push-buttons to operate a CD Player, CD Changer or Tape Recorder.

#### Numbered Push-buttons

Press Push-buttons 0 through 9 to access tuner station presets or CD tracks/discs.

#### Disc and Track

Use the DISC and TRACK Push-buttons when a CD player or changer is being used.

#### Tuner Push-buttons

Press the AM or FM Push-button to select the desired broadcast band. Press and release the Channel Up▲ or Down▼ Push-button to move from station to station. Press and hold a Channel Up▲ or Down▼ Push-button to move continuously from station to station. Press REVIEW to start the automatic brief audition of each of the presets stored in the tuner memory. Press REVIEW a second time to stop on a station preset and exit the Review process.

#### Volume

Press the Up▲ or Down▼ VOLUME Push-button to raise or lower the listening volume level.

*Note: The TAPE OUTPUTS are not affected by volume changes.*

#### Amplifier Selection

Press HOME Push-button followed by the SPEAKER 1 or 2 Push-buttons either separately or together, to control the Rear Panel OUTPUTS 1, 2 Jacks.

#### Acc On/Acc Off

Press ACC ON to turn the power ON to a McIntosh Disc Player. Press ACC OFF to turn the power OFF to a McIntosh Disc Player.

#### E

Press E to perform various functions on a variety of McIntosh Components. It will also pause the playing of a Disc or Tape Player.

#### Lighting

Press and release the LIGHTING Push-button to momentarily illuminate the upper half of the Remote Control Push-buttons.

*Note: While the LIGHTING Push-button is being depressed the Remote Control will be unable to send a remote command. When the LIGHTING Push-button is released the push-buttons will continue to stay illuminated for approximately three seconds thus allowing you to send the desired command.*

## How to Operate the C46

The McIntosh C46 Audio Control Center has been factory configured for operating settings that allow immediate enjoyment of superb high fidelity audio without the need for further adjustments. If you wish to make changes to the factory default settings, refer to the SETUP Section of this Owner's Manual.

### Power On and Off

Press the POWER switch to ON, the Red LED above the STANDBY/ON Push-button lights to indicate the C46 is in Standby Mode. To Switch On the C46 press the STANDBY/ON Push-button. Refer to figures 19 and 27.

*Notes: For normal operation, switch the C46 On and Off with the Standby/On Push-button. You may also turn On the C46 by simply pressing the Power Push-button on the Remote Control. If the Audio Control Center is not going to be used for an extended period of time, turn Off all AC Power with the Power Switch.*



Figure 19

### Source Selection

Select the desired Listening Source with the LISTEN Control and the Tape Output Source with the RECORD Switch. Refer to figures 20, 26 and 27.



Figure 20

### Volume Control

Adjust the VOLUME control for the desired listening level. Refer to figures 26 and 27.

### Volume Display

The Setup Volume Display Feature allows for the Front Panel Alphanumeric Display to indicate either Decibels (dB) or as an Percentage of the total volume. The dB readings range from -92dB to +15dB, in 0.5dB steps. Refer to figure 21. The % volume display reads from 0 to 100. Refer to figure 22. To change the Volume Display refer to page 15.



Figure 21



Figure 22

### Mute

Press the MUTE Push-button to mute audio in all Listen Outputs and the Front Panel Alphanumeric Display will indicate MUTE in place of the actual volume setting. Refer to figure 23.



Figure 23

### Balance Control

Adjust the BALANCE Control as needed to achieve approximately equal listening volume levels in each Loudspeaker. Rotate the BALANCE Control clockwise to emphasize the Right Channel by reducing the volume level of the Left Channel. Rotate the BALANCE Control counter-clockwise to de-emphasize the Right Channel until equal Balance of both Channels is achieved. As soon as the BALANCE control is turned, the Volume Display reads the balance change from 1 to 107 in one dB steps. Refer to figure 24.



Figure 24

After approximately 3 seconds the Volume Display returns to the Volume and Input Source indications. The C46 Front Panel "L" or "R" nomenclature located on either side of the Balance Control will illuminate red to indicate which channel has been emphasized by the BALANCE control. Refer to figure 25.

It is perfectly natural for the BALANCE control to be off the center to achieve the correct listening volume from each Loudspeaker in many listening rooms. Listening balance can also vary with different program sources, room acoustics and listening positions relative to the Loudspeakers. To verify the balance setting without changing it, move the control one detent in either direction.



Figure 25

**Tone Controls**

Each of the eight Tone Frequency Controls will raise or lower by approximately 12dB, the amplitude of the band of frequencies centered at the frequency marked above the controls. Both Left and Right Channels are affected. At the center detent or flat position of the controls, the tone circuit components are removed from the signal path. Refer to figure 26.

**Tone Bypass**

Press the TONE BYPASS Push-button to totally Bypass the Tone Control Circuitry, providing a flat frequency response. If the AUTOTONE circuit is set to the On position in Setup Mode, the C46 will remember for each input whether the Tone Bypass is active.

**Mono**

Press the Front Panel MONO Push-button or the MODE Push-button on the Remote Control to combine left and right stereo signals to mono at the Balanced and Unbalanced Listen OUTPUTS 1, 2 & MAIN; the HEADPHONES Output is also affected. The C46 will automatically remember for each Listen Input, whether the Stereo or Mono Mode has been selected. Refer to figure 26.

**Setup**

Pressing the SETUP Push-button activates the Setup Mode of the C46. This allows for customizing the Front Panel Alphanumeric Display Indications and the functioning of the C46. Refer to page 13 for additional information.

**Output 1 and 2**

Press OUTPUT 1 or 2 Push-buttons to send audio to separate power amplifiers connected to the rear panel OUTPUTS 1 or 2. It also activates the POWER CONTROL 1 &

2 Sockets on the rear panel of the C46. You can press either push-button individually or both together.

**Processors**

Press the LIS PROCESSOR Push-button to place an external Sound Processor into the Listen Signal Path for all inputs. In a similar manner, press the REC PROCESSOR Push-button to place an external Record Sound Processor into Tape Out Signal Path for both Tape & VCR Outputs. The C46 will automatically remember for each Listen and Record Input, whether the Listen and/or Record External Processor has been selected. Refer to figure 26.

**Record Monitor**

Press the REC MONITOR Push-button to hear the Signal Source that is available at the Tape and VCR Out Jacks for recording. Refer to figure 26.

*Note: If the Text Full Mode has been selected, the Front Panel Alphanumeric Display will display the Text Short Mode in order to indicate Selected Record Source.*



Figure 27



Figure 26

### How To Make A Tape Recording

The separate RECORD and LISTEN Controls allow you to make a tape recording from one program source while listening to another. You can also listen (monitor) to the recorded signal off the tape, a fraction of a second later, during recording when a three head tape recorder is used. You can also listen to the signal being fed to the tape recorder by pressing the REC MONITOR Push-button. Refer to figure 28.

1. Select the desired program source to record with the Front Panel RECORD Control.
2. Adjust the record level using the Recorder Volume Control.
3. To listen to the signal being fed to the recorder, press the REC (Record) MONITOR Push-button.
4. To listen to the tape playback of the program source just recorded, rotate the LISTEN Control to the desired input.

*Note: The C46 RECORD OUTPUTS are not affected by the VOLUME or BALANCE controls. To listen to a different program source while recording, rotate the LISTEN Control to the desired source. The recording process will not be affected and will continue.*

### Reset of Microprocessors

In the event that the controls of the C46 stop functioning, switch the POWER Switch to the Off Position and wait

about three minutes. Press the POWER Switch to the ON position and press the STANDBY/ON Push-button. This will reset the C46 microprocessors.

*Note: The above condition is usually caused by either interruptions in AC power and/or major changes in voltage.*

### Default Settings

To restore the C46 to Factory Default Settings perform the following. Press and hold the LISTEN Push-button together with the OUTPUTS 2 Push-button. Refer to figure 28. Approximately 5 seconds after holding in the two Front Panel Push-buttons together, the Front Panel Alphanumeric Display will indicate MASTER RESET. Refer to figure 29.



Figure 29

Release both Push-buttons and the Front Panel Alphanumeric Display will now indicate -- CLEARED -- and the C46 will switch Off. Refer to figure 30.



Figure 30

Press the STANDBY/ON Push-button on the C46 and proceed to the Setup on page 13 to re-enter the custom settings that have been previously made.



Figure 28

**Setup Re-Title Input Chart**

The Chart below is for recording any changes made to the C46 Input Titles. Refer to page 14.

Input Source Settings			
Input Number	Default Title	New Title	Trim
1	AUX		
2	TUNER		
3	CD		
4	CD2		
5	DVD		
6	SAT		
7	VCR		
8	TAPE		

A large grid area for recording changes to input titles and notes, consisting of approximately 20 columns and 30 rows of empty cells.

### Specifications

#### Frequency Response

+0, -0.5dB from 20Hz to 20,000Hz

#### Total Harmonic Distortion

0.002% maximum from 20Hz to 20,000Hz

#### Signal To Noise Ratio

Phono: 86dB (A Weighted)

High Level: 97dB (A Weighted)

#### Rated Output Voltage

2.5Vrms Unbalanced (Main and Outputs 1 and 2)

5Vrms Balanced (Main and Outputs 1 and 2)

#### Maximum Voltage Output

10Vrms Unbalanced (Main and Outputs 1 and 2)

20Vrms Balanced (Main and Outputs 1 and 2)

#### Output Impedance

240 ohms Unbalanced

480 ohms Balanced

#### Input Impedance

Phono:

47K ohms, 65pf

High Level:

22K ohms Unbalanced

47K ohms Balanced

#### Sensitivity

Phono:

4.5mV for rated output

High Level:

450mV for rated output Unbalanced

900mV for rated output Balanced

#### Maximum Input Signal

Phono:

50mV

High Level:

5V Unbalanced

5V Balanced

#### Voltage Gain

Phono to Tape Out: 40dB

High Level to Tape Out: 0dB

High Level to Main Out: 15dB

#### Power Requirements

100 Volts 50/60Hz, 50 watts

110 Volts 50/60Hz, 50 watts

120 Volts 50/60Hz, 50 watts

220 Volts 50/60Hz, 50 watts

230 Volts 50/60Hz, 50 watts

240 Volts 50/60Hz, 50 watts

*Note: Refer to the rear panel of the C46 for the correct voltage.*

#### Overall Dimensions

17-1/2 inches (44.45cm) W, 5-3/8 inches (13.69cm) H, 19 inches (48.26cm) D, including clearance for connectors

#### Weight

26 pounds (11.79 kg) net, 40.4 pounds (18.33 kg) in shipping carton

### Performance Chart

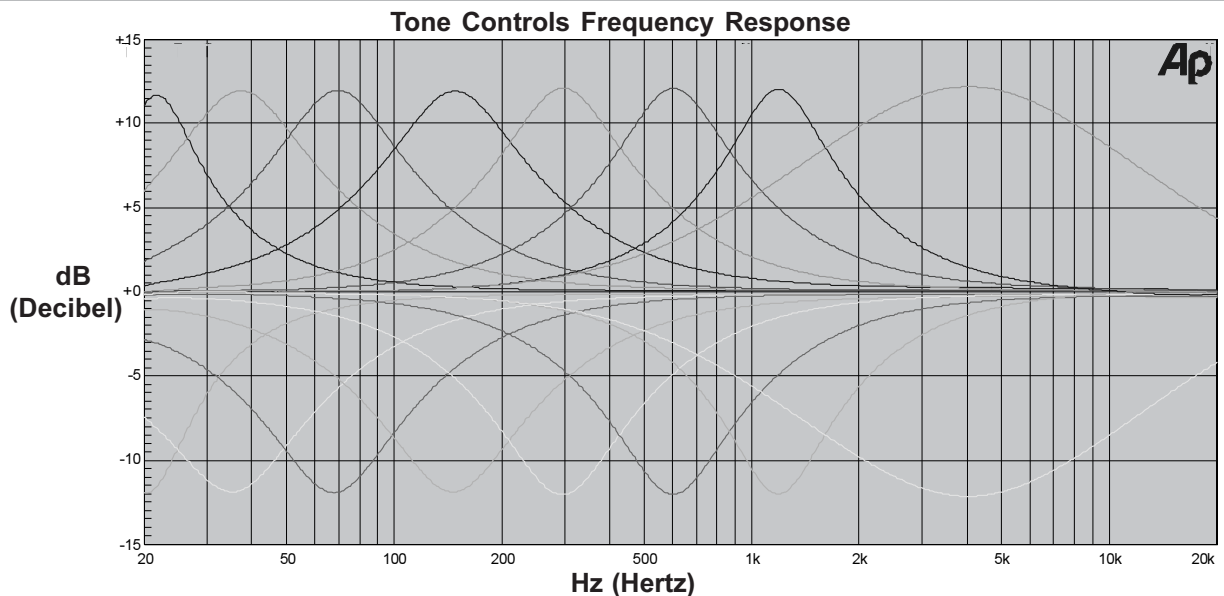

**Packing Instructions**

In the event it is necessary to repack the equipment for shipment, the equipment must be packed exactly as shown below. It is very important that the four plastic feet are attached to the bottom of the equipment. This will ensure the proper equipment location on the bottom pad. Failure to do this will result in shipping damage.

Use the original shipping carton and interior parts only if they are all in good serviceable condition. If a shipping carton or any of the interior part(s) are needed, please call or write Customer Service Department of McIntosh Laboratory. Please see the Part List for the correct part numbers.

Quantity	Part Number	Description
1	033838	Shipping carton only
4	033837	End cap
1	033836	Inside carton only
1	033725	Top pad
1	034194	Bottom pad
1	034837	Inner carton pad
4	017218	Plastic foot
4	100159	#10-32 x 3/4" screw
4	104083	#10-7/16" Flat washer

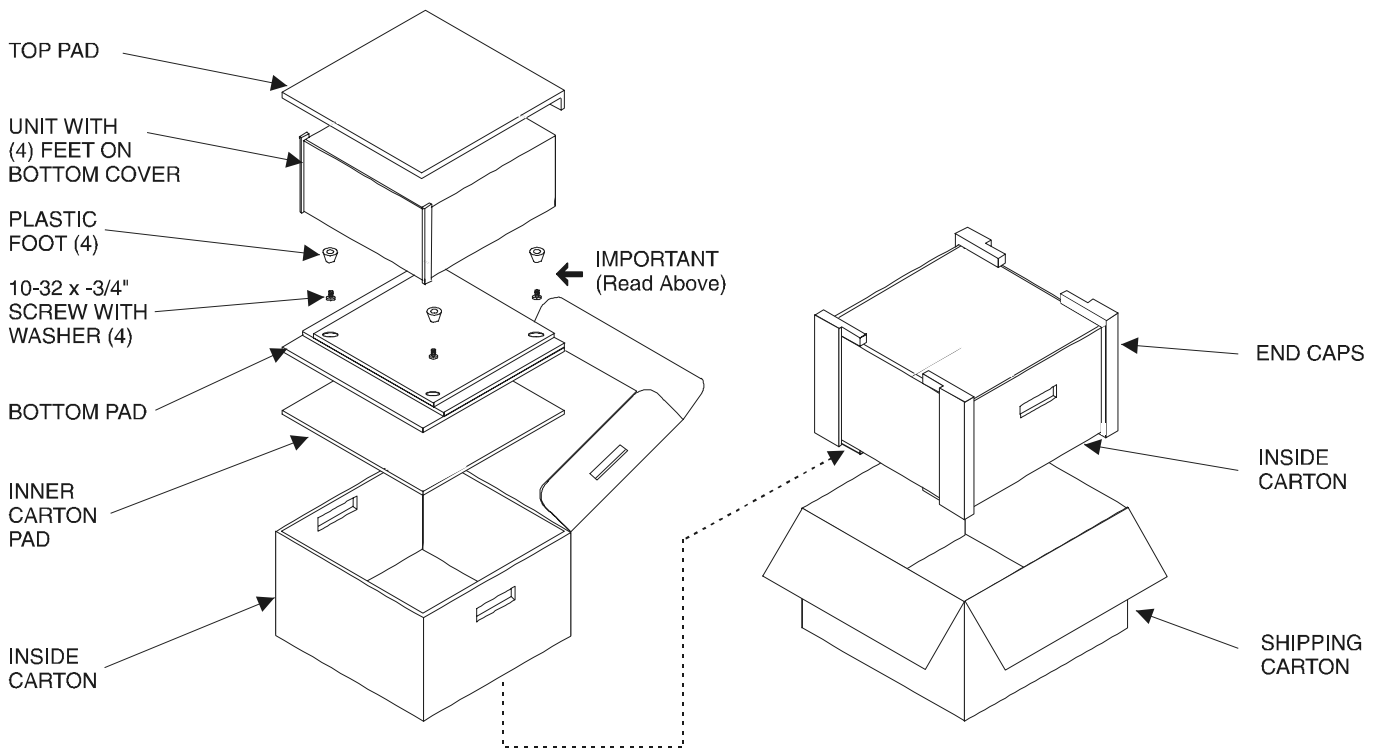



McIntosh Laboratory, Inc.  
2 Chambers Street  
Binghamton, NY 13903